

X1-Micro 4 in 1

**1300 W / 1500 W / 1600 W /
1800 W / 2000 W / 2200 W**

User Manual

Version 1.0

www.solaxpower.com



eManual in the QR code or at
<http://kb.solaxpower.com/>

STATEMENT

Copyright

Copyright © SolaX Power Network Technology (Zhejiang) Co., Ltd. All rights reserved.

No part of this manual may be reproduced, transmitted, transcribed, stored in a retrieval system, or translated into any language or computer language, in any form or by any means without the prior written permission of SolaX Power Network Technology (Zhejiang) Co., Ltd.

Trademarks



SOLA^X and other symbol or design (brand name, logo) that distinguishes the products or services offered by SolaX has been trademark protected. Any unauthorized use of above stated trademark may infringe the trademark right.

Notice

All or part(s) of the products, features and services described in this document may not be within your scope of purchase or usage. Unless otherwise specified in the contract, the contents, information and recommendations in this document are provided as is, SolaX makes no kind of warranties, guarantees or representations expressly or implicitly.

The content of the documents is continually reviewed and amended, where necessary. However, discrepancies cannot be excluded. SolaX reserves the right to make improvements or changes in the product(s) and the program(s) described in this manual at any time without the prior notice.

The images contained in this document are for illustrative purposes only and may vary depending on product models.

Please visit the website www.solaxpower.com of SolaX Power Network Technology (Zhejiang) Co., Ltd. for more information.

SolaX reserves all the right for the final explanation.

About This Manual

Scope of Validity

This manual is an integral part of X1-Micro 4 in 1 Series. It describes the installation, electrical connection, commissioning, maintenance and troubleshooting of the product. Please read it carefully before operating.

| | |
|---------------|---------------|
| X1-Micro 1300 | X1-Micro 1500 |
| X1-Micro 1600 | X1-Micro 1800 |
| X1-Micro 2000 | X1-Micro 2200 |

Note:

"X1-Micro" Series refers to the single-phase isolated microinverter that can convert direct current to alternating current.

"1300" refers to rated power 1300 W. "1500" refers to rated power 1500 W.

"1600" refers to rated power 1600 W. "1800" refers to rated power 1800 W.

"2000" refers to rated power 2000 W. "2200" refers to rated power 2200 W.



Target Group

The installation, maintenance and grid-related setting can only be performed by qualified personnel who

- Are licensed and/or satisfy state and local jurisdiction regulations.
- Have good knowledge of this manual and other related documents.

Conventions

The symbols that may be found in this manual are defined as follows.

| Symbol | Description |
|---|--|
|  DANGER | Indicates a hazardous situation which, if not avoided, will result in death or serious injury. |
|  WARNING | Indicates a hazardous situation which, if not avoided, could result in death or serious injury. |
|  CAUTION! | Indicates a hazardous situation which, if not avoided, could result in minor or moderate injury. |
| NOTICE! | Provides tips for the optimal operation of the product. |

Radio Interference Statement

This equipment has been tested and found to comply with the requirements of CE EMC, which means that it will not be affected by electromagnetic interference. However, there is no guarantee that interference will not occur in a particular installation.

If this equipment does cause harmful interference to radio or television reception, which can be determined by turning the equipment off and on, the user is encouraged to try to correct the interference by one or more of the following measures:

- Reorient or relocate the receiving antenna.
- Increase the separation between the equipment and receiver.
- Connect the equipment into an outlet on a circuit different from that to which the receiver is connected.
- Consult the dealer or an experienced radio/TV technician for help.

Change History

Version 01 (2024-06-06)

Updated 4.2 Microinverter Installation (added installation of AC cable)

Version 00 (2024-03-12)

Initial release

Table of Contents

| | | |
|----------|--|-----------|
| 1 | Safety | 1 |
| 1.1 | General Safety | 1 |
| 1.2 | Safety Instructions of PV, Inverter and Grid | 1 |
| 1.2.1 | Safety Instructions of PV | 2 |
| 1.2.2 | Safety Instructions of Microinverter | 2 |
| 1.2.3 | Safety Instructions of Utility Grid | 4 |
| 1.2.4 | Inverter backfeed current onto the array | 4 |
| 1.2.5 | Safety Instructions of AC trunk cable | 4 |
| 2 | Product Overview | 5 |
| 2.1 | Microinverter System Description | 5 |
| 2.2 | Highlights | 7 |
| 2.3 | Appearance | 7 |
| 2.3.1 | Overview | 7 |
| 2.3.2 | Dimensions | 7 |
| 2.3.3 | Terminals of Microinverter | 8 |
| 2.3.4 | Symbols on the Label and Microinverter | 8 |
| 3 | Preparation before Installation | 10 |
| 3.1 | Unpacking and Inspection | 10 |
| 3.1.1 | Unpacking | 10 |
| 3.2 | Packing Lists | 11 |
| 3.3 | Selection of Installation Location | 11 |
| 3.3.1 | Environment Requirement | 11 |
| 3.3.2 | Installation Angel Requirement | 12 |
| 3.4 | Tools Requirement | 13 |
| 3.4.1 | Recommended Equipment | 13 |
| 3.5 | AC Branch Circuit Capacity | 13 |
| 4 | Installation | 15 |
| 4.1 | Accessories | 15 |
| 4.2 | Microinverter Installation | 16 |
| 4.3 | Microinverter System Initiating | 24 |
| 4.3.1 | Initiate the System | 24 |
| 4.3.2 | Setup Monitoring System | 25 |
| 5 | Troubleshooting and Maintenance | 30 |
| 5.1 | LED Indicator Status | 30 |

| | | |
|----------|--|-----------|
| 5.2 | Troubleshooting..... | 30 |
| 5.3 | On-Site Inspection (for qualified installer only)..... | 32 |
| 5.4 | Maintenance..... | 33 |
| 5.4.1 | Maintenance routines | 33 |
| 5.4.2 | Upgrading Firmware..... | 34 |
| 6 | Decommissioning..... | 36 |
| 6.1 | Disassembling the Microinverter | 36 |
| 6.2 | Packing the Microinverter | 36 |
| 6.3 | Transportation and Storage..... | 37 |
| 6.4 | Disposal of the Microinverter | 37 |
| 7 | Technical Data | 38 |
| 8 | Appendix | 42 |
| 8.1 | INSTALLATION MAP..... | 42 |
| 8.2 | WIRING DIAGRAM – 230VAC SINGLE PHASE..... | 43 |
| 8.3 | WIRING DIAGRAM –120VAC 240VAC SPLIT PHASE..... | 44 |
| 8.4 | WIRING DIAGRAM – 230VAC THREE PHASE..... | 45 |
| 8.5 | WIRING DIAGRAM 120VAC 208VAC Three-Phase..... | 46 |

1 Safety

1.1 General Safety

The series inverter has been meticulously designed and thoroughly tested to comply with the relevant state and international safety standards. Nevertheless, like all electrical and electronic equipment, safety precautions must be observed and followed during the installation of the inverter to minimize the risk of personal injury and ensure a safe installation.

Please thoroughly read, comprehend, and strictly adhere to the comprehensive instructions provided in the user manual and any other relevant regulations prior to the installation of the inverter. The safety instructions in this document serve as supplementary guidelines to local laws and regulations.

SolaX shall not be liable for any consequences resulting from the violation of the storage, transportation, installation, and operation regulations outlined in this document. Such consequences include, but are not limited to:

- Inverter damage caused by force majeure events, such as earthquakes, floods, thunderstorms, lightning, fire hazards, volcanic eruptions, and similar events.
- Inverter damage due to human causes.
- Usage or operation of the inverter in violation of local policies or regulations.
- Failure to comply with the operation instructions and safety precautions provided with the product and in this document.
- Improper installation or usage of the inverter in unsuitable environmental or electrical conditions.
- Unauthorized modifications to the product or software.
- Inverter damage occurring during transportation by the customer.
- Storage conditions that do not meet the requirements specified in this document.
- Installation and commissioning performed by unauthorized personnel who lack the necessary licenses or do not comply with state and local regulations.

1.2 Safety Instructions of PV, Inverter and Grid

Save these important safety instructions. Failure to follow these safety instructions may result in damage to the inverter and injury or even loss of life.

1.2.1 Safety Instructions of PV



Lethal danger from electric shock due to the PV!

- Never touch the positive or negative pole of PV connecting device. Touching both of them at the same time is prohibited as well.
- Do not ground the positive or negative pole of the PV modules.
- Only qualified personnel can perform the wiring of the PV modules.



- Make sure that the input DC voltage \leq Maximum DC input voltage of the microinverter. Overvoltage may cause permanent damage to the Microinverter , which is NOT covered by the warranty.

1.2.2 Safety Instructions of Microinverter



Risk of electric shock, fire and hot surface!

- If the equipment runs abnormally, do not use it by force. Otherwise, electric shock or fire may occur.
- Do not open the enclosure in any case without authorization from SolaX. Unauthorized opening will void the warranty and cause lethal danger or serious injury due to electric shock.
- Only qualified and experienced electrician can perform the installation, wiring, maintenance of the microinverter following this document and related rules and regulations.
- Authorized service personnel must use insulated tools and wear protective equipment when installing or working with this equipment.
- Keep away from flammable, explosive materials to avoid fire disaster.
- Risk of high-voltage and hot surface! Ensure the device are within the limit of safe voltage potential and temperature before touching any part of the microinverter.



- Check if all components are intact in case of equipment damage during or after installation.

 **WARNING!**

- The installation place should be away from humid or corrosive substance. Avoid installation near extremely hot/cold environment.
- Please consult the manufacturer for non-standard installation conditions.
- Make sure that the microinverter is installed under the PV module in case of direct exposure to UV, rain and other harmful weather events.
- Avoid mounting the microinverter upside down and always install the microinverter guide rail side up.

 **WARNING!**

- Avoid matching microinverters to cables that have been exposed to wet conditions.
- Avoid connecting batteries or other sources of power supply to each input of the microinverter, as each input is connected to one PV module.
- The operating conditions shall be within the range of Technical Data listed in this manual.
- Never connect or disconnect the AC or DC connectors when the microinverter is running. Please turn off the microinverter before any operation of the AC or DC connectors.
- Make sure that the AC branch circuit is de-energized before servicing.

 **CAUTION!**

- Children should be supervised to ensure that they do not play with the appliance.

NOTICE!

- Before installing and maintaining the equipment, please read the User Manual and Installation Guide.
- Comply with local safety rules and regulations before all electrical installations
- All the product labels and nameplate on the microinverter shall be maintained clearly visible.

1.2.3 Safety Instructions of Utility Grid

NOTICE!

- Only with permissions of local utility grid company, the microinverter can be connected to the grid.
- The installer must provide Over Current Protection Devices (OCPD) and external disconnect switches.

1.2.4 Inverter backfeed current onto the array

NOTICE!

This requirement protects against overloading of array wiring due to backfeed currents from the inverter.

For example, such currents can be generated when fault conditions allow currents derived from other sources such as the mains or a battery to flow out of the PV input terminals of the inverter. If this backfeed current is limited to the maximum normal current the array can source, wiring and other devices in the current path will be adequately sized to carry the backfeed current without overload. If this backfeed current is not limited to the maximum normal current, providing the value of the max current to the installer is critical to allow determination of any increase in wiring sizes or added overcurrent protection necessary.

1.2.5 Safety Instructions of AC trunk cable

DANGER!

- Avoid installing the AC trunk cable connectors while power is connected.

WARNING!

- Check if the AC trunk cable conductors are not damaged. Only when the exposed wires are not damaged, the system can function properly.
- Install the protective sealing caps on the unused AC connectors,
- Secure the loose AC trunk cables to reduce tripping hazard.
- Never leave the AC connectors on the AC trunk cable uncovered.

2 Product Overview

2.1 Microinverter System Description

A microinverter system is composed of PV grid-connected microinverters, PV modules, and grid. Microinverter data are transmitted to SolaX monitoring platform SolaXCloud.

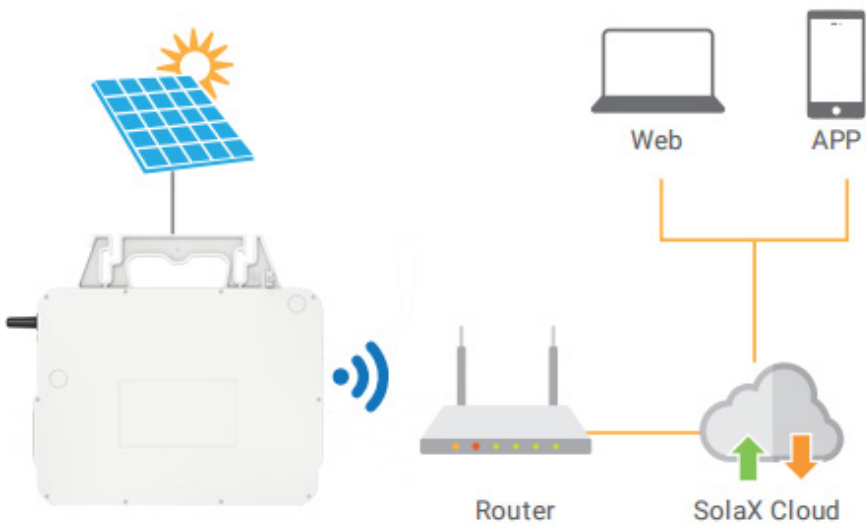

Figure 2-1 System overview diagram

X1-Micro 4 in 1 series

The X1-Micro 4 in 1 series manages system energy. Microinverters convert the direct current power generated from the PV modules into grid-compatible AC current. They send their operation data and the output information of PV modules to the monitoring platform, including PV voltage, current, power, etc., which is the foundation of the module-level monitoring.

Microinverters are divided into 1 in 1, 2 in 1, 4 in 1, etc., resting with how many PV modules it connects, which means that a microinverter can be linked to 1/2/4 modules separately. This manual focuses on 4 in 1 series.

PV grid-connected microinverter, a module-level solar Microinverter, is capable of effectively solving the single point of failure in the photovoltaic power generation system. The microinverter can work by tracking the maximum DC power point of each PV module, which is known as Maximum Power Point

Tracking (MPPT).

The X1-Micro 4 in 1 is integrated with MPPT, which means that even though a PV module runs abnormally or is shaded, other modules won't be affected and can operate the unshaded string at maximum efficiency point. This function plays an important role to improve the efficiency of a photovoltaic (PV) generation system.

Furthermore, X1-microinverter device only carries a relatively low DC voltage, mitigating the risk of electric shock.

PV module

A PV Module is an assembly of photovoltaic cells, also known as solar cells. To achieve a required voltage and current, a group of PV modules are wired into strings which are called PV arrays. A PV module is the essential component of any PV system that converts sunlight directly into direct current electricity.

Grid

220V / 230V/ 240V grid are supported.

SolaXCloud

SolaXCloud is an intelligent, multifunctional monitoring platform that can be accessed either remotely or through a hard wired connection. With the SolaX Cloud, the operators and installers can always view key and up-to-date data and set it remotely. You can log in to your user account at any time through a personal computer, IOS or Android device to view real-time monitoring data or historical data, and perform remote settings as needed.

2.2 Highlights

- Max output power up to 2200VA with four independent input channels(MPPT)
- Up to 20A DC input current to be compatible with the high power PV module
- Built-in industrial grade Wi-Fi module for high reliability
- Safety protection relay integrated
- Support micro-grid, AC coupling solution with existing storage system
- Support the integration of a single-phase microinverter into a three-phase power grid system
- With Reactive Power Control and Rapid Shutdown Function
- Easy to install and maintain with small size, light weight
- IP67 protection class, more reliable

2.3 Appearance

2.3.1 Overview

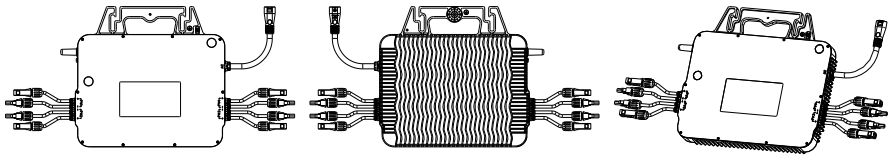

Figure 2-2 Appearance

2.3.2 Dimensions

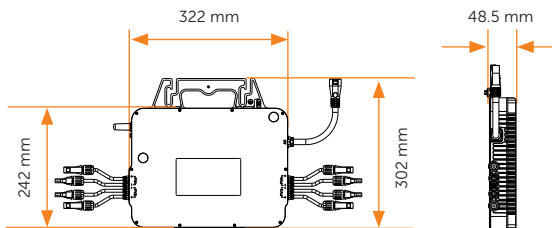

Figure 2-3 Dimensions

2.3.3 Terminals of Microinverter

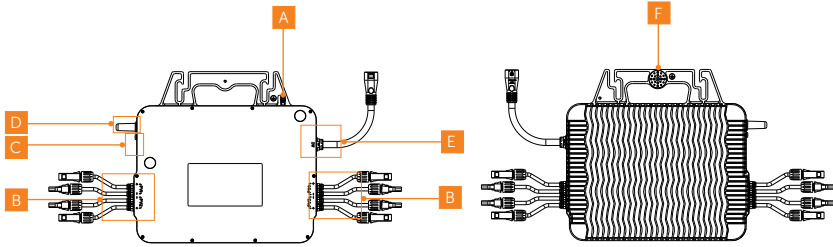





Figure 2-4 Terminals of Microinverter





Table 2-1 Description of terminals

| No. | Item | Description |
|-----|-------------------------|--|
| A | Spare ground cable clip | For standby earth connection. |
| B | PV terminal | For PV connection. |
| C | Indicator | Show the status of the device. |
| D | Antenna | To receive and transmit WiFi signal. |
| E | AC terminal | For AC connection. |
| F | Earth lug | A connection component for electrical devices which need grounding (perferred grounding method). |

2.3.4 Symbols on the Label and Microinverter

Table 2-2 Description of symbols

| Symbol | Description |
|---|--|
|  | CE mark. The microinverter complies with the requirements of the applicable CE guidelines. |
|  | Beware of hot surface. The microinverter can become hot during operation. Avoid contact during operation. |
|  | Danger of high voltages. Danger to life due to high voltages in the Microinverter ! |
|  | Danger. Risk of electric shock! |

| Symbol | Description |
|--|---|
|  | Refer to the operating instructions. |
|  | The microinverter can not be disposed together with the household waste. Disposal information can be found in the enclosed documentation. |
|  | ANATEL certification. |
|   | Danger of high voltage. Do not touch live parts for 5 minutes after disconnection from the power sources. |

3 Preparation before Installation

3.1 Unpacking and Inspection

3.1.1 Unpacking

- The microinverter undergoes 100% testing and inspection before shipping from the manufacturing facility. However, transport damage may still occur. Before unpacking the Microinverter, please verify that the model and outer packing materials for damage, such as holes and cracks.
- Please unpack the microinverter according to the following figure.

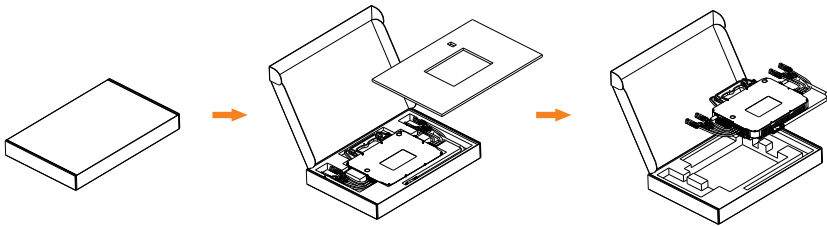
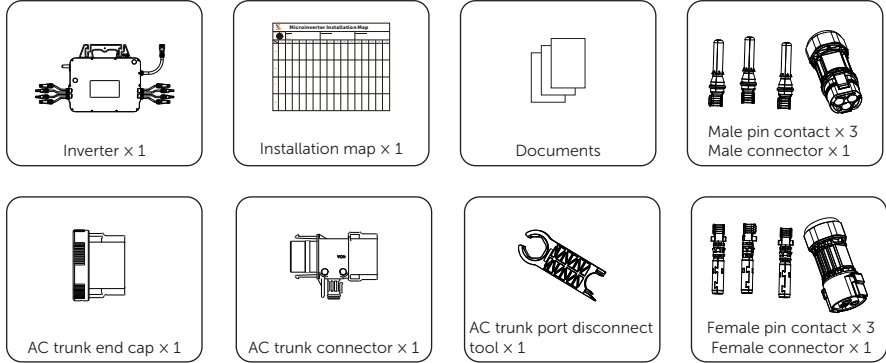

Figure 3-1 Unpacking the Microinverter

- Be careful when dealing with all package materials which may be reused for storage and relocation of the microinverter in the future.
- Upon opening the package, check whether the appearance of the microinverter is damaged or lack any accessories. If any damage is found or any parts are missing, contact your dealer immediately.

3.2 Packing Lists

Including in the box:



Sold separately:

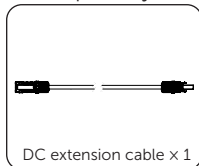

* Refer to the actual delivery for the optional accessories. The quantity of materials in the packing list above is the recommended quantity for one microinverter. If you need to install multiple microinverters, the actual situation prevails.

3.3 Selection of Installation Location

The installation location selected for the microinverter is quite critical in the aspect of the guarantee of machine safety, service life and performance.

- It has the IP67 ingress protection, which allows it to be installed outdoor;
- The installation position shall be convenient for wiring connection, operation and maintenance.

3.3.1 Environment Requirement

- The ambient temperature: -40°C to $+65^{\circ}\text{C}$;
- The humidity shall be between 0-100%;
- Do not install the microinverter in the areas where the altitude exceeds 3000 m;
- Install the microinverter in a well-ventilated environment for heat dissipation;
- Do not install the microinverter in areas with flammable, explosive and corrosive materials;

Preparation before Installation

- Do not install the microinverter in areas near combustibles and antennas;
- Install all microinverters and DC connectors under the PV modules.
- Avoid direct exposure to UV, rain and other harmful weather events.
- Avoid electromagnetic interference in case of the malfunction of electronic equipment.

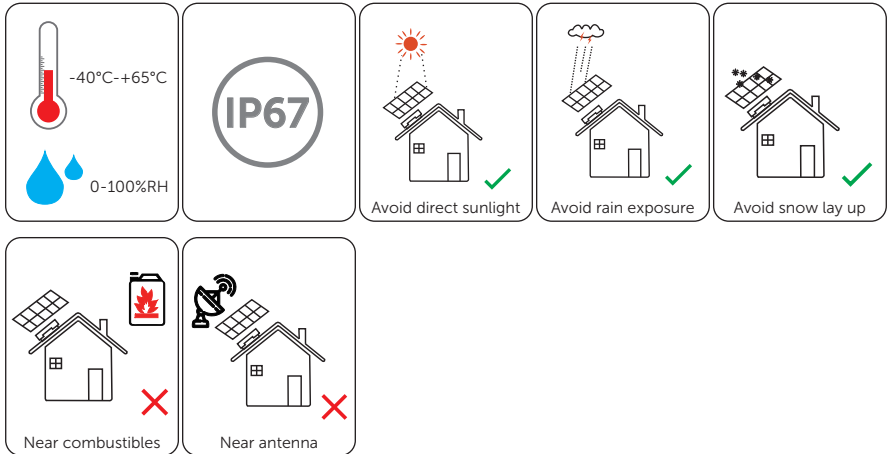

NOTICE!

- For outdoor-installation, precautions against direct-sunlight, rain -exposure and snow-accumulation are-recommended.
- Exposure to direct sunlight raises the temperature inside the device. This temperature rise poses no safety risks, but-may impact the device performance.

3.3.2 Installation Angel Requirement

NOTICE!

- Install the microinverter on the bracket. Make sure the bracket is parallel with the rail.

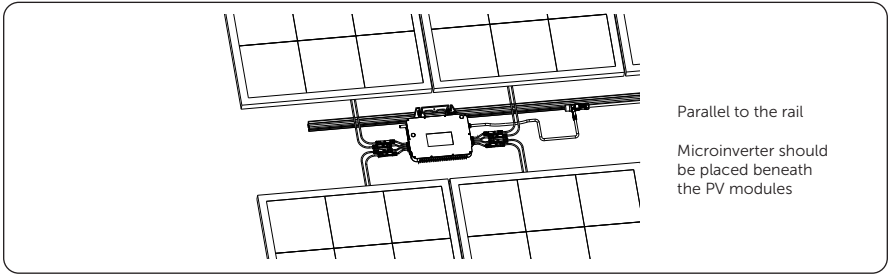
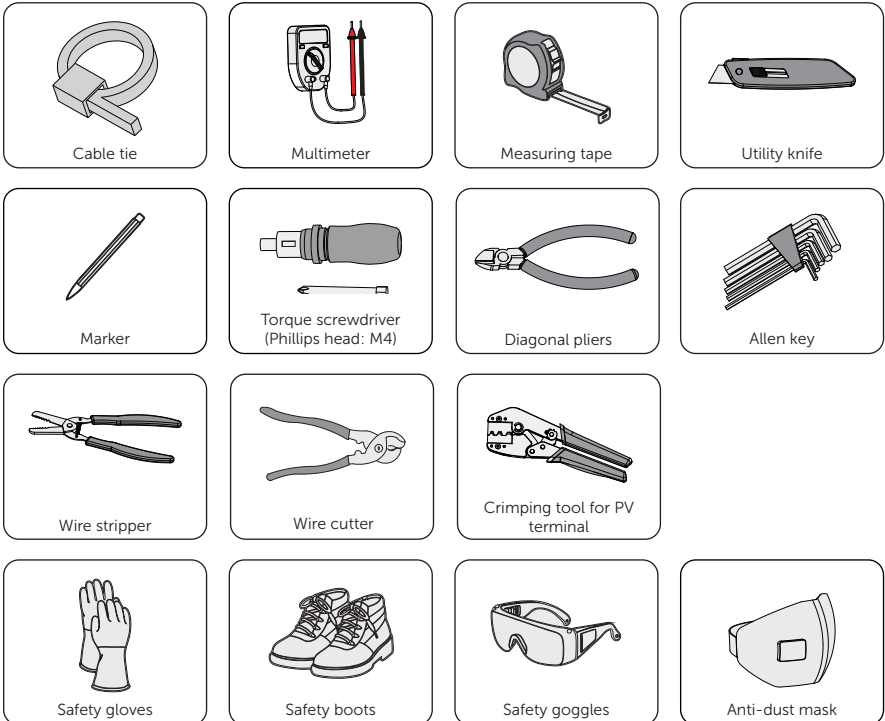

Figure 3-1 Correct installation

3.4 Tools Requirement

3.4.1 Recommended Equipment

Installation tools include but are not limited to the following recommended ones. If necessary, use other auxiliary tools on site.



3.4.2 Additional required materials

| No. | Required Material | Requirements |
|-----|--------------------|--|
| 1 | AC circuit breaker | Current: 50A for 10 AWG/40 A for 12 AWG (If there are additional safety regulations, please refer to the local safety regulations) |
| 2 | Guide rail | According to actual needs |
| 3 | Sliding block | Matching with the guide rail |
| 4 | Screw | Matching with the guide rail |
| 5 | AC cable | 4-6 mm ² ; three-core soft wire cable |

3.5 AC Branch Circuit Capacity

X1-Micro 1300/1500/1600/1800/2000/2200 can be used with the provided AC Trunk Cable and AC Trunk Connectors. The maximum number of microinverters on each AC branch is listed as follows:

| | X1-Micro 1300 | X1-Micro 1500 | Maximum over current protection device |
|---------------------------------|----------------------------|----------------------------|--|
| Maximum number per 10AWG branch | 6@220V 7@230V 7@240V | 5@220V 6@230V 6@240V | 50 A |
| Maximum number per 12AWG branch | 5@220V 5@230V 5@240V | 4@220V 4@230V 5@240V | 40 A |

| | X1-Micro 1600 | X1-Micro 1800 | Maximum over current protection device |
|---------------------------------|----------------------------|----------------------------|--|
| Maximum number per 10AWG branch | 5@220V 5@230V 6@240V | 4@220V 5@230V 5@240V | 50 A |
| Maximum number per 12AWG branch | 4@220V 4@230V 4@240V | 3@220V 4@230V 4@240V | 40 A |

| | X1-Micro 2000 | X1-Micro 2200 | Maximum over current protection device |
|---------------------------------|----------------------------|----------------------------|--|
| Maximum number per 10AWG branch | 4@220V 4@230V 4@240V | 4@220V 4@230V 4@240V | 50 A |
| Maximum number per 12AWG branch | 3@220V 3@230V 3@240V | 3@220V 3@230V 3@240V | 40 A |

Note:

An AC branch can connect to 1 in 1/2 in 1/4 in 1 microinverters at the same time, provided that the total current is less than the AC branch circuit capacity stipulated in local rules and regulations.

How many microinverters that each AC branch can connect depends on the current-carrying capacity of the cable.

4 Installation

4.1 Accessories

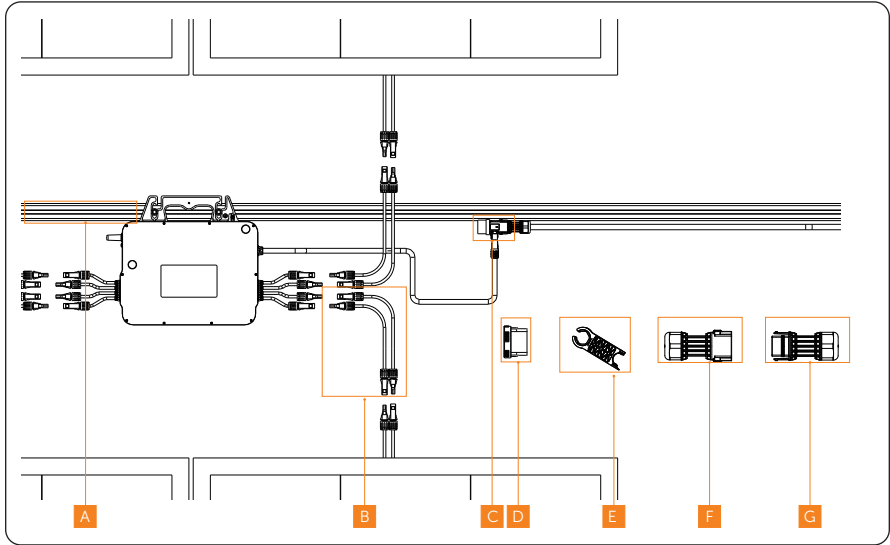

| No. | Description |
|-----|-----------------------------------|
| A | 1.2m/2m/2.4m AC trunk cable |
| B | DC extension cable (if necessary) |
| C | AC trunk connector |
| D | AC trunk end cap |
| E | AC trunk port disconnect tool |
| F | Female connector |
| G | Male connector |

NOTICE!

- The above accessories are not included in the package and need to be purchased separately.

4.2 Microinverter Installation

! WARNING!

- Avoiding pulling or holding the AC cable with your hand directly. Hold the handle of the microinverter instead.

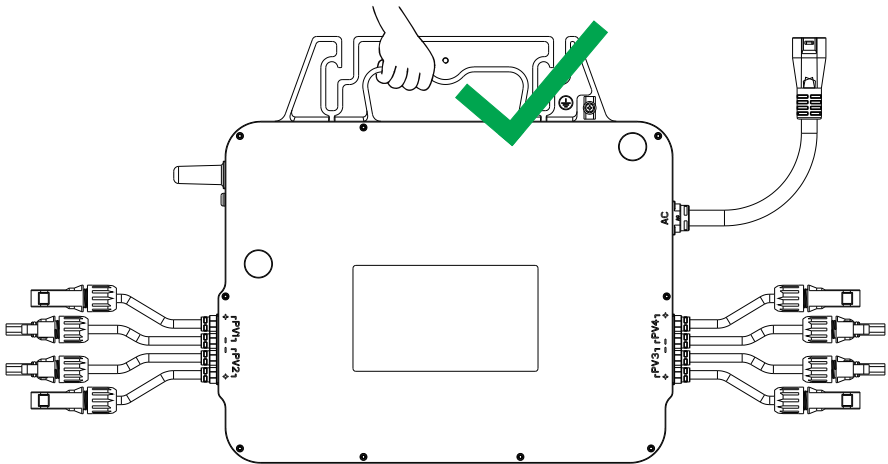
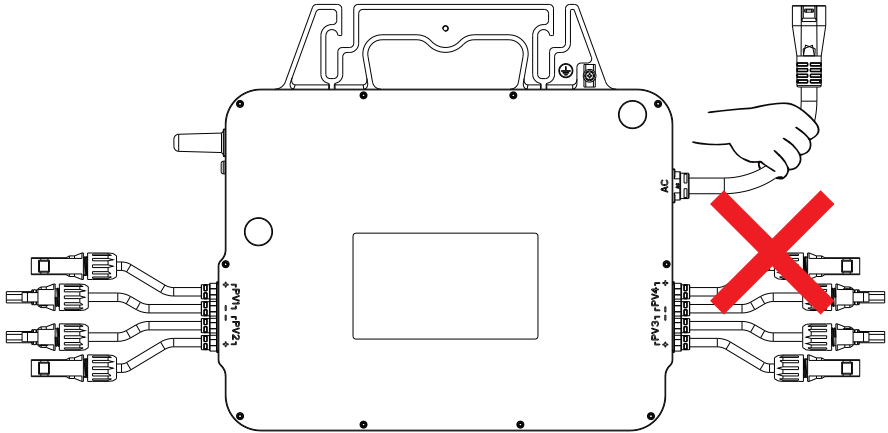

! WARNING!

- Pay attention to the earth lug. Risk of hand injury!

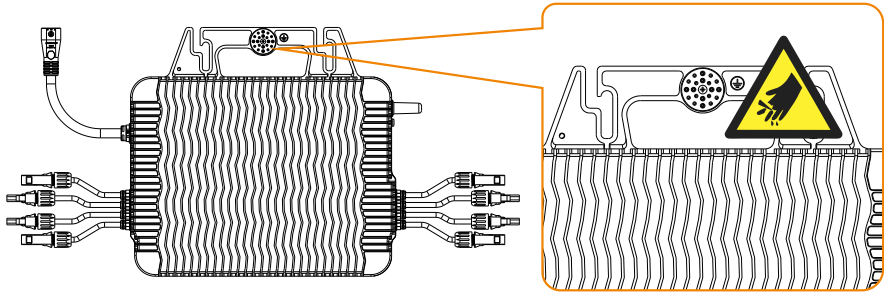

Step 1: Rail Installation

A) The installer has to install the rails on the roof and fix them with screws to ensure a stable installation environment for microinverters.

Step 2: Plan the Number and Installation Location of Microinverters

A) Arrange the installation number and location of each microinverter according to the layout of the photovoltaic system.

B) Use a marker to mark the suitable areas of the rail for installing microinverters.

NOTICE!

- Please adjust the terminal location on the AC trunk cable according to the distance between microinverters for a stable connection.

Step 3: Install the Microinverter on the Rail

A) Place the sliding bolcks and screws on the marked place of the rail.

B) Hang on microinverters. The silver cover side with performance table of the microinverter shall be placed upwards.

C) Tighten the screws.

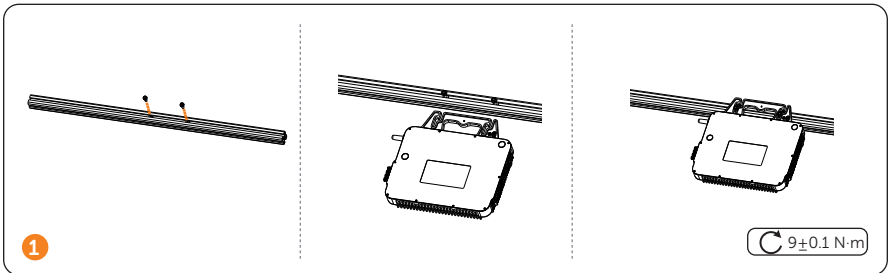

NOTICE!

- Choose the screwdriver according to the corresponding screws of the rail.

Step 4: Build the AC trunk cable**NOTICE!**

- Please use 4-6 mm² three core soft wire cable. Single core hard wire cable cannot be used in the following steps.

A) Disassemble the Male connector into four parts: part I, part II, part III and part IV.

B) Strip the AC trunk cable (about 40 mm) and then strip L, N and PE cable (about 9 mm) inside the AC trunk cable.

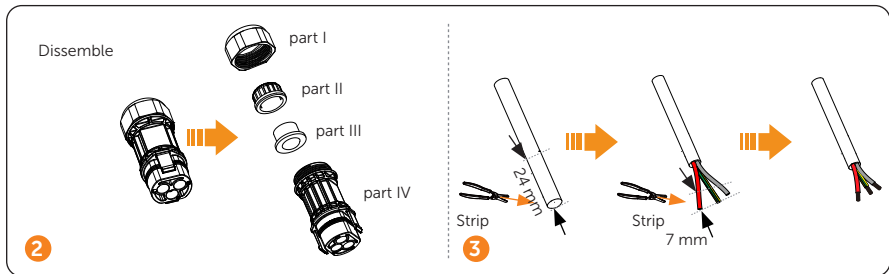

C) Connect the male pin contacts to L, N and PE cables and crimp pin contacts.

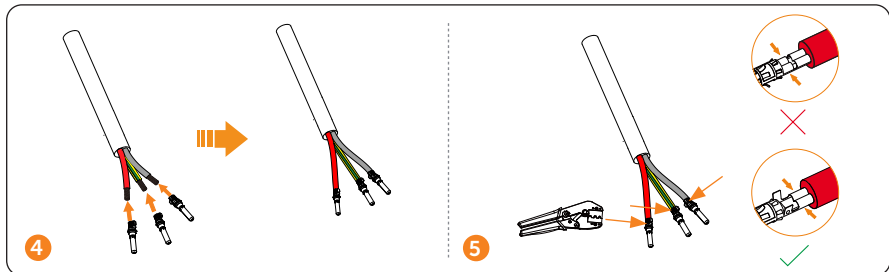

D) Thread part I, part II and part III into the AC trunk cable. Thread L, N and PE cables into the corresponding hole of part IV. Screw down part IV with part I.

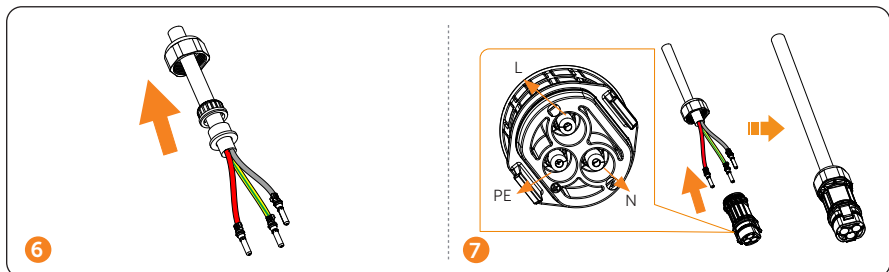

NOTICE!

- The connection between female connector and AC trunk cable is the similar to that of male connector. Connect female connector with female pin contact and install the female connector at the other side of AC trunk cable.

NOTICE!

- Choose the cable tie according to the rail width and the length of self-purchased accessories.
- Avoid placing AC connectors nearby any drainage channels.
- AC trunk connectors should be placed nearby the AC cable of microinverters.
- Select the AC cable with an appropriate length according to the actual installation situation

Step 5: Place AC Trunk Cable on the Rail

A) Place the AC trunk connector on the rail inwards (as shown below) and band it with cable ties.

NOTICE!

- The connection between female connector and AC trunk cable is the similar to that of male connector. Connect female connector with female pin contact and install the female connector at the other side of AC trunk cable.

NOTICE!

- Choose the cable tie according to the rail width and the length of self-purchased accessories.
- Avoid placing AC connectors nearby any drainage channels.
- AC trunk connectors should be placed nearby the AC cable of microinverters.

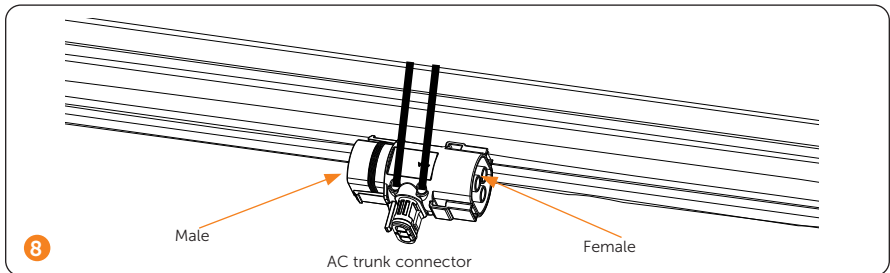

B) Plug the male terminal of AC trunk cable into the female terminal of AC trunk connector.

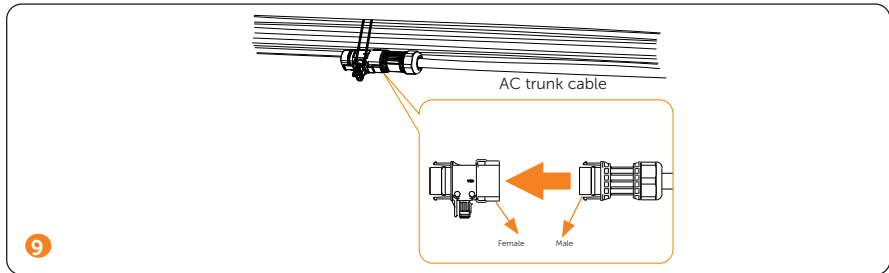

NOTICE!

- The male head of the AC trunk connector connected to the first microinverter needs to be connected with the AC Trunk End Cap.

NOTICE!

- In order to better fix the AC trunk cable, it is recommended to use more cable ties to band the AC trunk cable.

C) Band the AC trunk cable with cable ties. In order to better fix the AC cable, it is recommended to use more cable ties to band the AC cable.

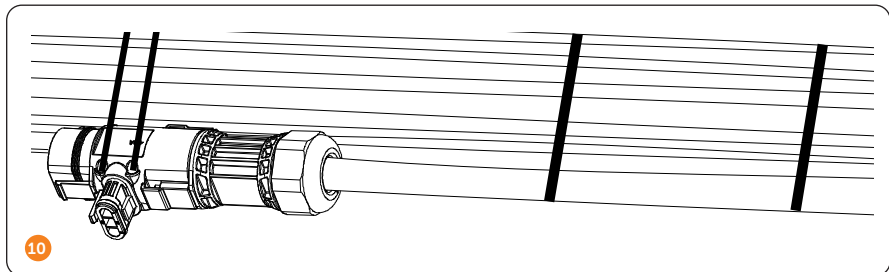

D) Repeat this step in sequence.

NOTICE!

- When connecting AC cables in the middle, please follow the diagram below.

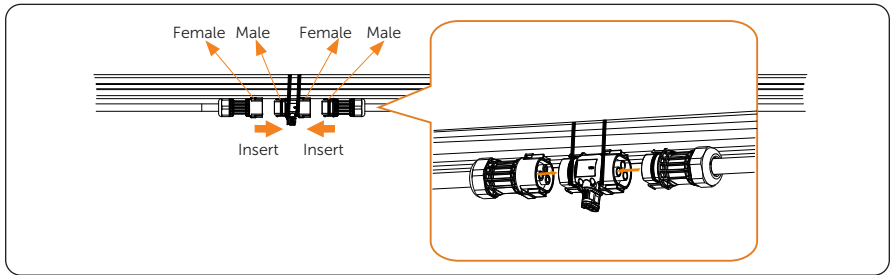

E) Cover vacant AC ports with AC trunk end cap.

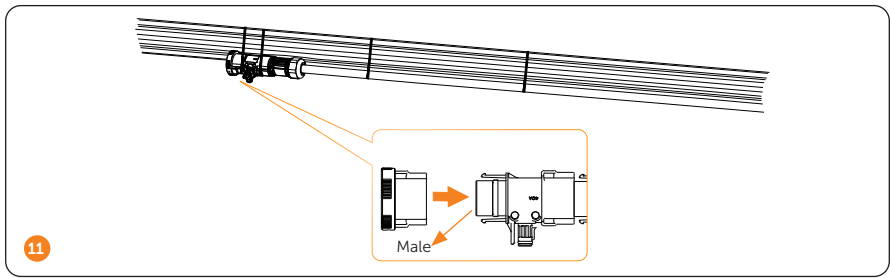

Step 6: AC Trunk Cable Connection

A) Plug the AC connector of the microinverter into the trunk cable connector. The connection is completed when you hear a "click".

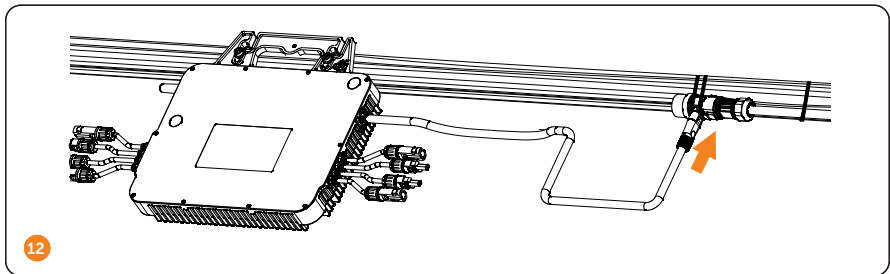

NOTICE!

- If you need to disconnect the AC connector from the AC cable, use the AC Trunk Port Disconnect Tool (see packing list).

Step 7: Complete the Installation Map

A) Remove the serial number label on the machine and attach to the installation map following the planned installation place.

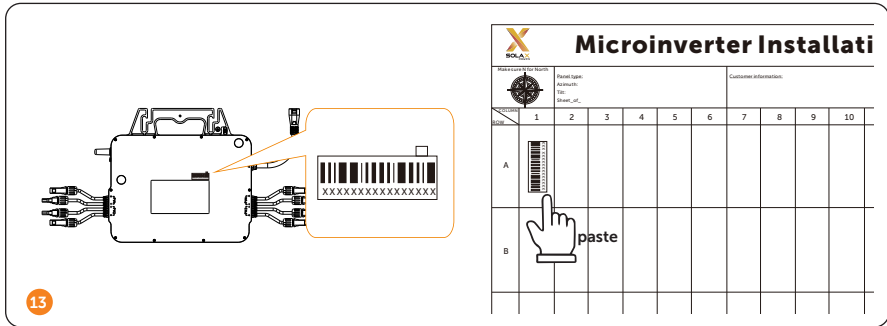

Step 8: Grounding methods

We provide two grounding methods for this series of microinverters. If the earth lug doesn't touch the rail or the rail is not on the ground, please try method 2.

NOTICE!

- Choose the suitable grounding method according to local safety regulations.

Method 1 (major grounding method): Let the earth lug touch the rail.

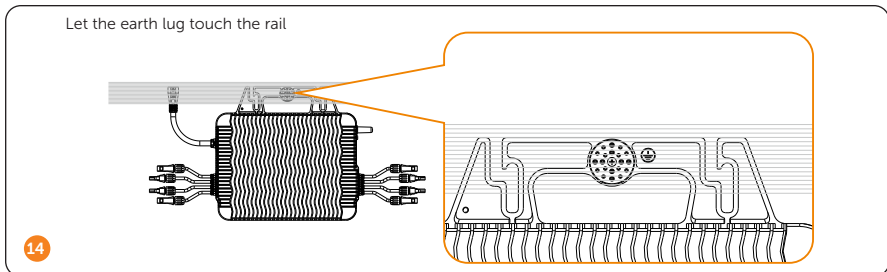

Method 2: Strip the PE cable, place the PE cable on the rail and fix it with screws.

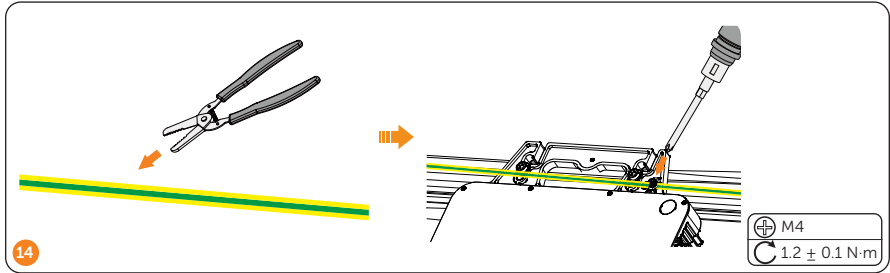

Step 9: Connect Multiple PV Modules to Microinverter

NOTICE!

- At least two or three trained and experienced workers are required to finish this step.

WARNING!

- Please connect PV terminals in the correct way. Reverse connection may damage the microinverter!

A) One or two workers hold the PV panel nearby microinverter, while the other one connects PV terminals of each microinverter to the corresponding DC cable of PV module.

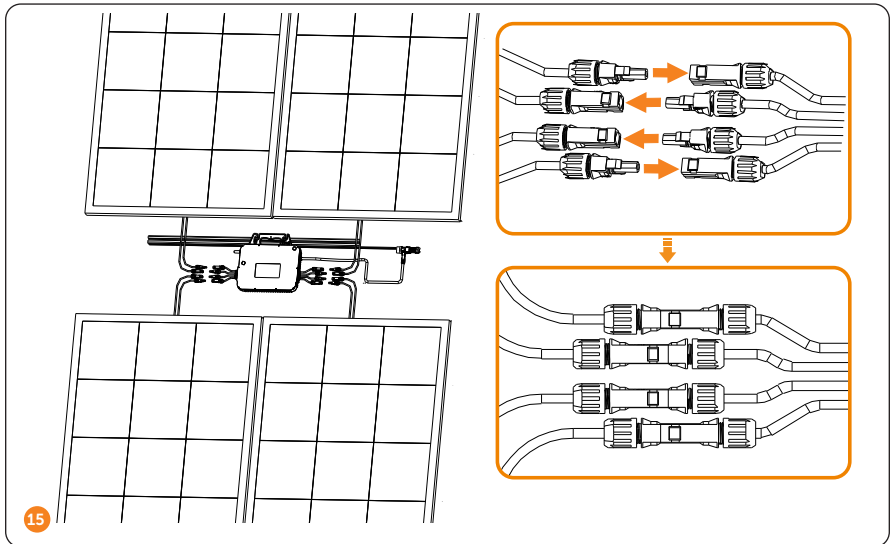

NOTICE!

- If the panels are too far from the microinverter, please use DC extension cables for connection.

B) Cover the PV modules above the microinverters and fix the PV panels.

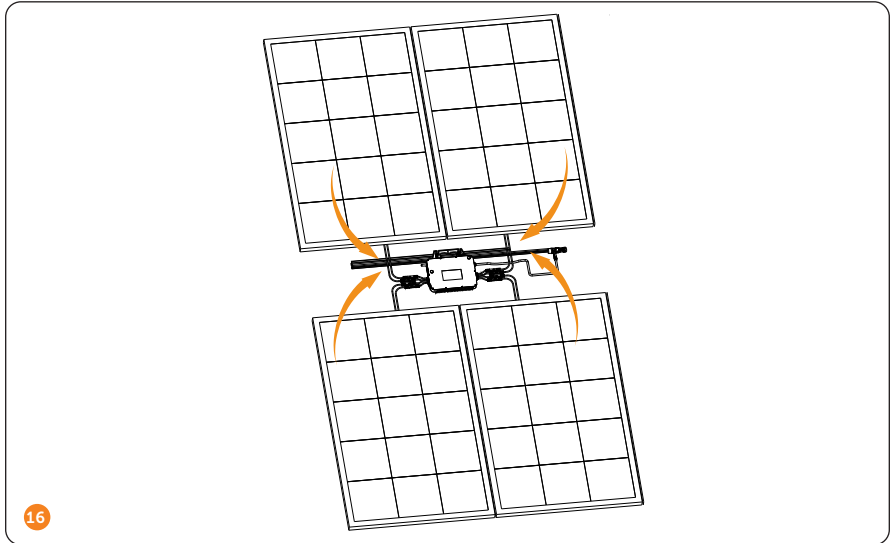
**NOTICE!**

- The length of AC end cable shall depends on the actual installation scene.

C) Then connect it to the local grid.

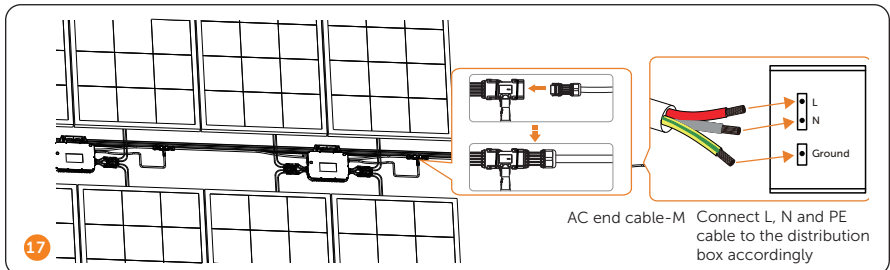

NOTICE!

- If you didn't buy AC end cable-M, please follow the procedures below to make the wire before connecting to the distribution box.
- Please use 4-6 mm² three core soft wire cable. Single core hard wire cable cannot be used in the following steps.

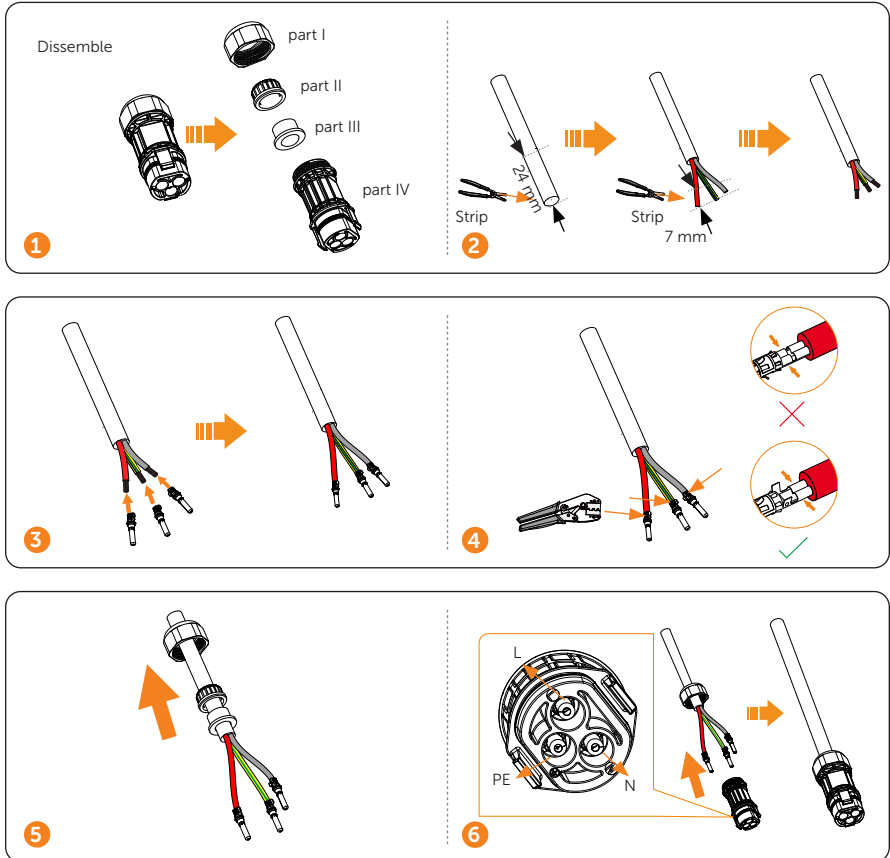

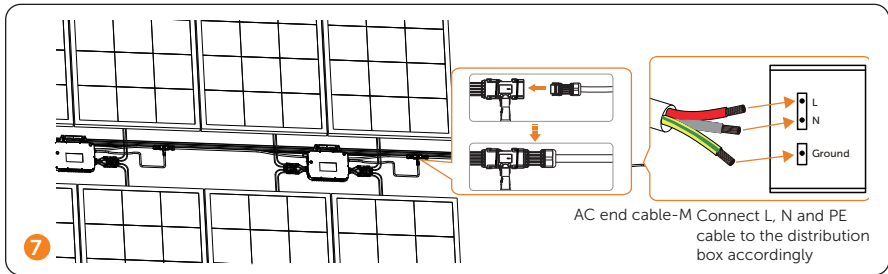

4.3 Microinverter System Initiating

4.3.1 Initiate the System

- Checking before Power-on
 - » Check the device installed correctly and securely;
 - » All AC cables are connected correctly and securely;
 - » All DC cables are connected correctly and securely;
 - » Make sure all photovoltaic panels are connected correctly and securely;
 - » Make sure all the connectors which are not used should be sealed by covers;
 - » Make sure the microinverter is installed under the PV modules;
 - » Make sure all the connectors are free of water.

Step 1: First turn on the AC breaker on the branch circuit and then the main AC breaker of the house.

Step 2: Wait for about 2 minutes until the system is initiated.

4.3.2 Setup Monitoring System

Downloading and installing App

Select and scan the QR code below to download SolaxCloud APP. You can also find the QR codes at the top left of the login page of www.solaxcloud.com or on the user manual of Pocket series communication module. In addition, you can search with the key word SolaxCloud in Apple Store or Google Play to download it.



App Registration and Login

- a. Run the App, select the language, and touch [Sign up] at the bottom of Monitoring App.

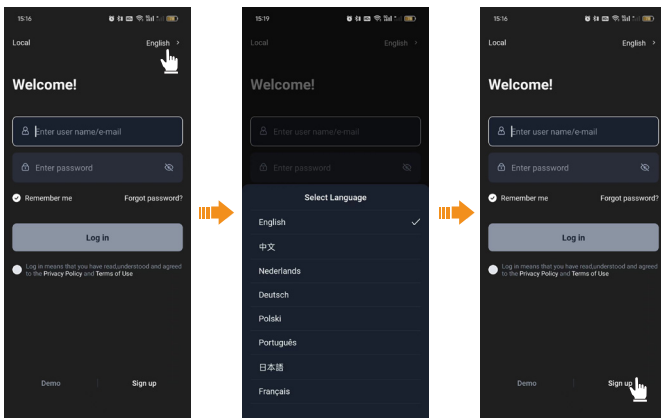

- b. Choose your identity as [Distributor/Installer] or [End User]. Fill in your registration Email, input the Verification code, and enter your password to create the account. Log in the App after registration finished.

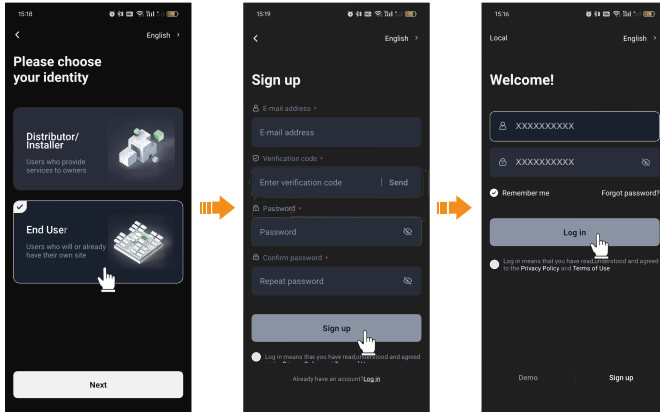

NOTICE!

- App registration via **Sign up** is for end-users. If you want to apply for an account of agent, please send an email to: service@solaxpower.com.

Add Site

- a. Create a site by filling in the site information.

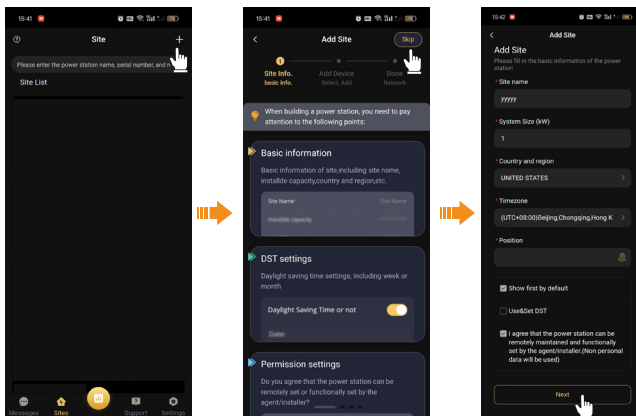

Network Configuration

NOTICE!

- Before Network configuration, make sure the DC or AC side of the microinverter has been energized and the dongle module has been connected to "Upgrade/Dongle" port of the Microinverter .

a. Click [Microinverter], scan the QR code of microinverter to bind the device.

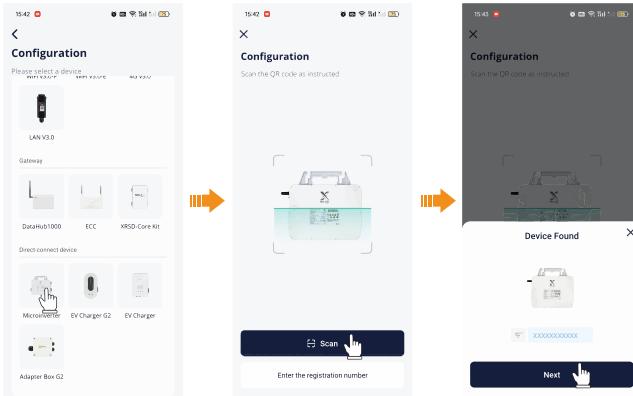

NOTICE

- If scanning the QR code step fails, then try to scan the one dimensional code. Scanning one dimensional code may lead to inaccurate scan results).

b. Enter your WiFi account and password. Then, connect the device hotspot (name: Wifi_XXXXXXXXXX), start to configure the device network.

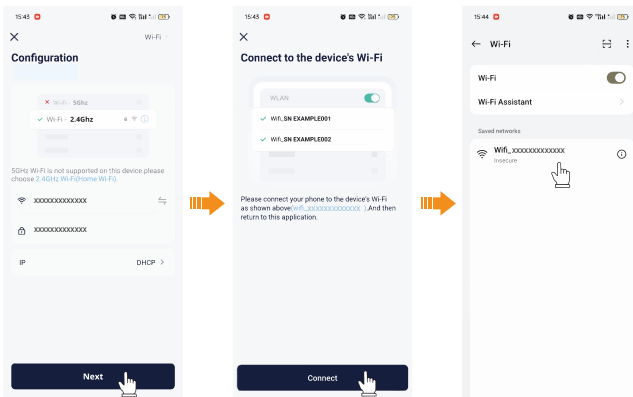

- c. Wait for a while, the microinverter will configure network automatically. After configuration succeeds, please remember to change to your home WiFi for the following operations.

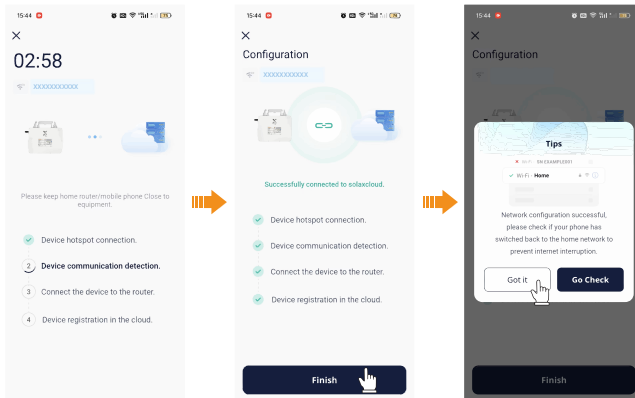

- d. Click [Layout] to customize your device layout and save the settings.

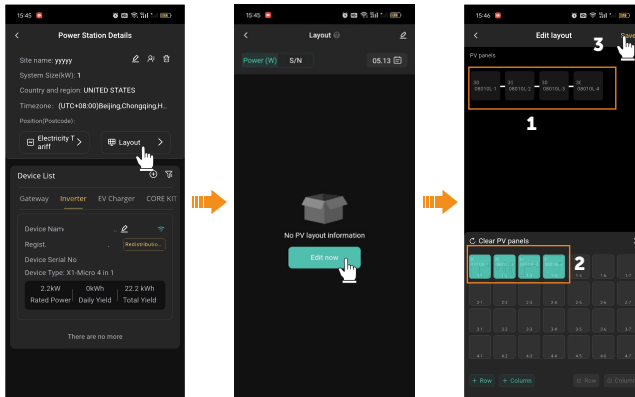

- e. Click the site to view your device detail information.

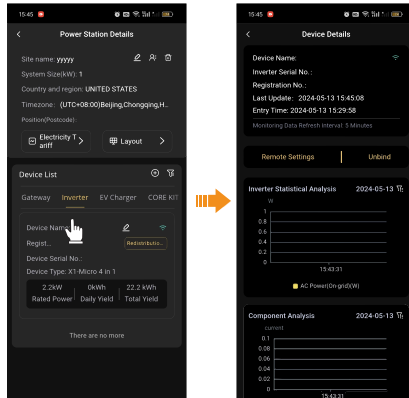

5 Troubleshooting and Maintenance

5.1 LED Indicator Status

| LED Indicator Status | Description |
|------------------------|--|
| Yellow light flash | Microinverter startup. If the light flashes once in 1s, flashes in 10s or still flashes after 10s, microinverter startup fails or DSP firmware is upgrading. |
| Yellow light steady on | Microinverter standby/self-checking. |
| Green light flash (5s) | Normal operation; normal AC grid; communicating with router. |
| Green light flash (2s) | Normal operation; normal AC grid; no connection with router. |
| Red light flash (2s) | No AC grid or AC grid outside the regulatory range. |
| Red light steady on | Error: non-grid abnormal fault. Machine fault like grounding detection fault and PV side fault. |

About 10s after connection with DC power, the light turns yellow;

The yellow light flashes for 10s continuously and then keeps steady on which stands for microinverter self-check;

Afterwards, if the system is not powered on, the red light will flash, indicating for no grid existence;

After microinverter connects with DC power for the first time, red light flashes indicates for errors during microinverter startup.

5.2 Troubleshooting

This section contains information and procedures for resolving possible problems with the Microinverter, and provides the troubleshooting tips to identify and solve most problems that may occur. Please check the warning or fault information on the App and read the suggested solutions below when error occurs. Contact SolaX Customer Service for further assistance. Please be prepared to describe the details of your system installation and provide the model and serial number of the Microinverter.

| Code | Faults | Diagnosis and solutions |
|--------|---------------|---|
| IE0001 | TzFault | Over Current Fault. |
| | | -Wait for about 10 seconds to check if the inverter is back to normal. |
| | | -Disconnect the DC switch and restart the inverter. |
| IE0002 | GridLostFault | -Or seek help from us. |
| | | Grid Lost Fault. |
| | | -Check if the mains cable is loose. |
| | | -Wait for a while and the system will reconnect when the utility is back to normal. |
| | | -Or seek help from us. |

Troubleshooting and Maintenance

| Code | Faults | Diagnosis and solutions |
|---------|------------------|---|
| IE0003 | GridVoltFault | <p>Grid Voltage Out of Range.</p> <p>-Check if the mains cable is loose.</p> <p>-Wait for a while and the system will reconnect when the utility is back to normal.</p> <p>-Or seek help from us.</p> |
| IE0004 | GridFreqFault | <p>Grid Frequency Out of Range.</p> <p>-Wait for a while and the system will reconnect when the utility is back to normal.</p> <p>-Or seek help from us.</p> |
| IE0005 | PvVoltFault | <p>PV Voltage Fault.</p> <p>-Check whether the PV is overvoltage.</p> <p>-Or seek help from us.</p> |
| IE0006 | BusVoltFault | <p>DC Bus Voltage Out of Normal Range.</p> <p>-Check if the PV input voltage is within the operating range of the inverter.</p> <p>-Disconnect PV wiring and reconnect.</p> <p>-Or seek help from us.</p> |
| IE0008 | GridVolt10MFault | <p>Grid Overvoltage for Ten Minutes Fault.</p> <p>-The system will reconnect when the utility is back to normal.</p> <p>-Or seek help from us.</p> |
| IE0009 | DclnJOC | <p>DCI Overcurrent Protection Fault.</p> <p>-Wait for a while to check if the inverter is back to normal.</p> <p>-Or seek help from us.</p> |
| IE00011 | SW OCP Fault | <p>Software Overcurrent Protection Fault.</p> <p>-Wait for a while to check if the inverter is back to normal.</p> <p>-Disconnect PV and grid, then reconnect.</p> <p>-Or seek help from us.</p> |
| IE0013 | IsoFault | <p>Isolation Fault.</p> <p>-Check the connections of the inverter.</p> <p>-Or seek help from us.</p> |
| IE0014 | TempFault | <p>Over Temperature Fault.</p> <p>-Check if the inverter and the ambient temperature exceeds the operating range.</p> <p>-Or seek help from us.</p> |
| IE0028 | EepromFault | <p>DSP EEPROM Fault.</p> <p>-Disconnect PV wiring and reconnect.</p> <p>-Or seek help from us.</p> |

| Code | Faults | Diagnosis and solutions |
|--------|----------------|---|
| IE0030 | PvConnDirFault | PV Direction Fault. -Check if the PV+/- sides are connected correctly. -Or seek help from us. |
| IE0031 | GridRelayFault | Relay Fault. -Check the grid connection. -Restart the inverter. -Or seek help from us. |
| IE0036 | PowerTypeFault | PowerTypeFault: -Check the version of Module and DSP. -Check the product SN number. -Or seek help from us. |

5.3 On-Site Inspection (for qualified installer only)

Follow the steps below to troubleshoot a malfunctioning microinverter.

Step 1: Check the voltage and frequency of utility do not exceed the range described in Technical Data of this manual.

Step 2: Check the connection to the utility grid.

WARNING!

- Risk of electric shock! Prior to servicing, always de-energize the AC branch circuit first.
- Avoid disconnecting the DC connectors under load.

Step 3: Check the connection between microinverters on the AC branch circuit.

Step 4: Check if all the AC breakers runs normally and are closed.

Step 5: Check the DC connection between microinverters and the PV modules.

Step 6: Check the DC voltage of PV modules is within the range decribed in Technical Data of this manual.

Step 7: If the microinverter remains malfunctioning after the above steps, please consult our service support or apply for machine replacement.

WARNING!

- Never repair the malfunctioning mircoinverter by yourself!

5.4 Maintenance

Regular maintenance is required for the Microinverter. The table of “Proposal of Maintenance” below lists the operational maintenance for expressing the optimum device performance. More frequent maintenance service is needed in the worse work environment. Please make records of the maintenance.



- Only qualified person can perform the maintenance for the Microinverter .
- Only use the spare parts and accessories approved by SolaX for maintenance.

5.4.1 Maintenance routines

| Item | Check Notes | Maintenance Interval |
|-----------------------|--|----------------------|
| Safety check | <ul style="list-style-type: none"> • Check the items mentioned in section 1 “Safety” • The safety check shall be performed by manufacturer’s qualified person who has adequate training, knowledge, and practical experience. | Every 12 months |
| Indicators | <ul style="list-style-type: none"> • Check if the indicators of the microinverter are in normal state. • Check if the display of the microinverter is normal. | Every 6 months |
| Electrical connection | <ul style="list-style-type: none"> • Ensure that all cables are firmly connected. • Check the integrity of the cables, ensuring that there are no scratches on the parts touching the metallic surface. • Verify that the sealing caps on idle terminals are not falling off. | Every 6 months |

Table 5-3 Proposal of Maintenance

5.4.2 Upgrading Firmware

Upgrade precautions

WARNING!

- If the DSP and Integrated WiFi Module firmware need to be upgraded, please note that WiFi Module firmware must be upgraded first, then DSP firmware!
- Please make sure that the category format is correct, do not modify the firmware file name. Otherwise, the microinverter may not work!

WARNING!

- For the Microinverter, ensure that the PV input voltage is greater than 20 V (upgrade on sunny days). Otherwise, it may cause serious failure during the upgrade process!

CAUTION!

- If the firmware upgrade of Integrated WiFi Module or DSP fails or stops, please check whether the input voltage of PV module is greater than the microinverter startup voltage, and then repeat the upgrade steps.

Upgrade steps

- Log into www.solaxcloud.com to upgrade the microinverter.

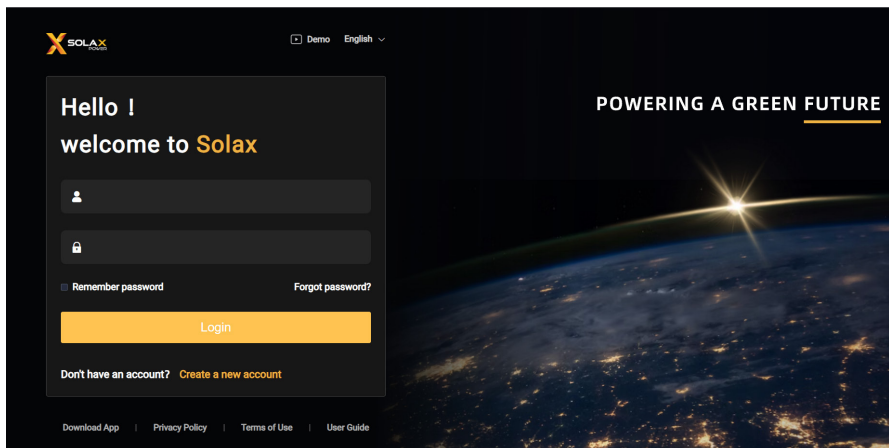

Troubleshooting and Maintenance

- b. Click **Upgrade Firmware**, **Add**, and fill in the information and upload firmware. Click **Sure** to finish firmware upgrade.

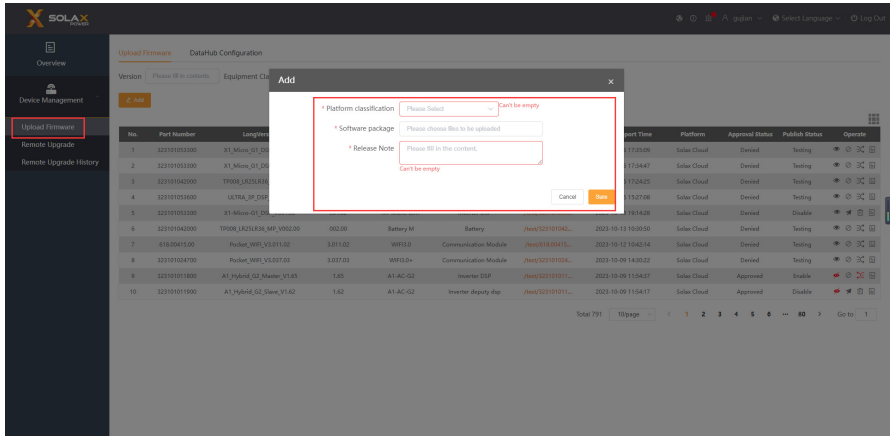

- c. Select **Remote Upgrade**, choose the microinverter you want to upgrade and click the upgrade icon.

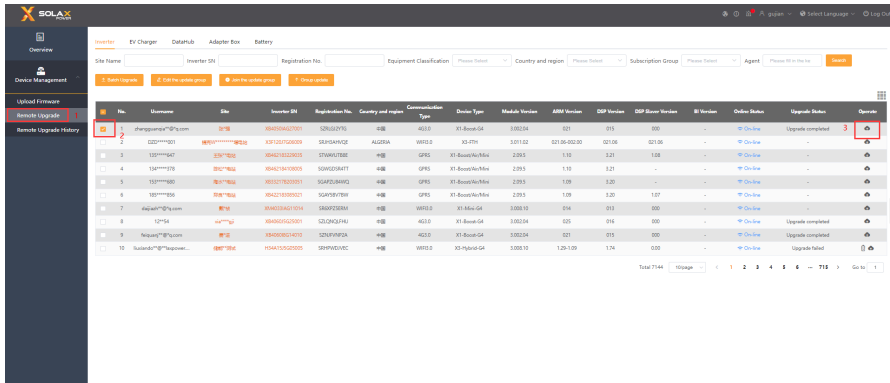

- d. If you need batch upgrade, please select **Equipment Classification**, **Applicable Model** and **Update program** first. Then choose the models you want to upgrade, and click **Batch Upgrade**.

6 Decommissioning

6.1 Disassembling the Microinverter

- a. To disassembling the microinverter
 - » De-energize the AC breaker.
 - » Dismount the PV module from the guide rail for meter detection.
 - » Use a meter to check the DC cables and make sure no current flow exists in the wires between microinverter and module.
 - » Use an AC disconnect tool to remove AC sub connectors.

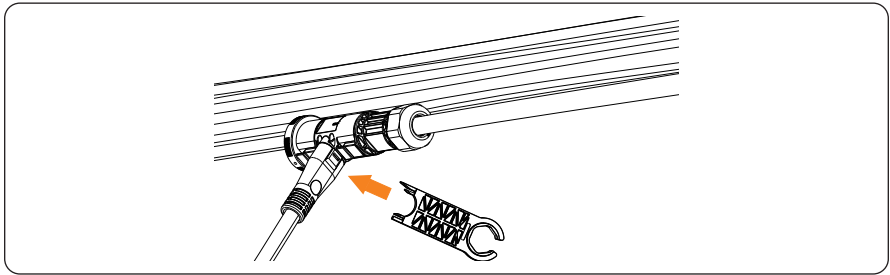

- » Screw off the screw of microinverter and remove the device from the guide rail.
- b. To replace the microinverter in our monitoring platform
 - » Use APP to scan or type in the SN of the microinverter to be used.
 - » Make sure the AC breaker is turned off and install the microinverter according to Installation Steps described in this manual.
 - » In SolaXCloud app, unbind the original microinverter and bind new model

6.2 Packing the Microinverter

- Load the microinverter into the original packing material if possible.
- If the original packing material is not available, you can also use the packing material which meets the following requirements:
 - » Suitable for the weight of product.
 - » Easy to carry
 - » Be capable of being closed completely

6.3 Transportation and Storage

If the microinverter is not put into use immediately, the transportation and storage requirements needs to be met:

Transportation

- Observe the caution signs on the packaging of microinverter before transportation.
- Wear protective gloves when carrying the equipment by hand to prevent injuries.

Storage

- The microinverter must be stored indoors.
- Do not remove the original packaging material and check the outer packaging material regularly.
- The storage temperature should be between -40°C and $+65^{\circ}\text{C}$. The humidity should be between 0% and 100%.
- Stack the microinverter in accordance with the caution signs on the microinverter carton to prevent their falling down and device damage. Do not place it upside down.

6.4 Disposal of the Microinverter

Please dispose of the Microinverters or accessories in accordance with the disposal regulations for electronic waste applied at the installation site.

7 Technical Data

• DC Input

| Model | X1-Micro 1300 | X1-Micro 1500 | X1-Micro 1600 |
|--|---------------|---------------|---------------|
| Max. recommended DC power [W] | 300 to 505+ | 320 to 540+ | 360 to 600+ |
| Max. PV voltage [d.c. V] | | 60 | |
| MPPT voltage range [d.c. V] | | 22-60 | |
| Max. PV current [d.c. A] | 4 × 12 | 4 × 14 | 4 × 15 |
| Isc PV array short circuit current [d.c. A] | 4 × 20 | 4 × 20 | 4 × 22 |
| Max inverter backfeed current to the array [d.c.A] | | 0 | |
| Start output voltage [d.c. V] | 20 | 20 | 20 |
| No. of MPPT trackers | | 4 | |
| Strings per MPPT tracker | 1 | 1 | 1 |

| Model | X1-Micro 1800 | X1-Micro 2000 | X1-Micro 2200 |
|--|---------------|---------------|---------------|
| Max. recommended DC power [W] | 400 to 600+ | 400 to 670+ | 400 to 670+ |
| Max. PV voltage [d.c. V] | | 60 | |
| MPPT voltage range [d.c. V] | 4 × 16 | 4 × 18 | 4 × 19.5 |
| Max. PV current [d.c. A] | 4 × 22 | 4 × 22 | 4 × 22 |
| Isc PV array short circuit current [d.c. A] | | 4 × 30 | |
| Max inverter backfeed current to the array [d.c.A] | | 0 | |
| Start output voltage [d.c. V] | 20 | 20 | 20 |
| No. of MPPT trackers | | 4 | |
| Strings per MPPT tracker | 1 | 1 | 1 |

• AC Output

| Model | X1-Micro 1300 | X1-Micro 1500 | X1-Micro 1600 |
|--|---------------|-----------------------------|---------------|
| Rated output apparent power [VA] | 1300 | 1500 | 1600 |
| Maximum continuous output power [VA] | 1300 | 1500 | 1600 |
| Nominal AC voltage [a.c. V] ¹ | | 220 or 230 or 240 / 180-264 | |
| Nominal AC frequency [Hz] ¹ | | 50/60 | |

| Model | X1-Micro 1300 | X1-Micro 1500 | X1-Micro 1600 |
|--|----------------------------|---------------|---------------|
| Maximum continuous output current [A] | 5.91@220V | 6.82@220V | 7.28@220V |
| | 5.66@230V | 6.53@230V | 6.96@230V |
| | 5.42@240V | 6.25@240V | 6.67@240V |
| Power factor range | >0.99(-0.8~0.8 adjustable) | | |
| Maximum units per 10 AWG branch ² | 6@220V | 5@220V | 5@220V |
| | 7@230V | 6@230V | 5@230V |
| | 7@240V | 6@240V | 6@240V |
| Maximum units per 12 AWG branch ² | 5@220V | 4@220V | 4@220V |
| | 5@230V | 4@230V | 4@230V |
| | 5@240V | 5@240V | 4@240V |
| Current inrush [a.c. A] | 12 | | |
| Max output fault current [a.c. A] | 16 | | |
| Max output overcurrent protection [a.c. A] | 15 | | |
| Total harmonic distortion [%] | <3 | | |

| Model | X1-Micro 1800 | X1-Micro 2000 | X1-Micro 2200 |
|--|-----------------------------|---------------|---------------|
| Rated output apparent power [VA] | 1800 | 2000 | 2200 |
| Maximum continuous output power [VA] | 1800 | 2000 | 2200 |
| Nominal AC voltage [a.c. V] ¹ | 220 or 230 or 240 / 180-264 | | |
| Nominal AC frequency [Hz] ¹ | 50/60 | | |
| Maximum continuous output current [A] | 8.19@220V | 9.10@220V | 10.00@220V |
| | 7.83@230V | 8.70@230V | 9.57@230V |
| | 7.50@240V | 8.34@240V | 9.17@240V |
| Power factor range | >0.99(-0.8~0.8 adjustable) | | |
| Maximum units per 10 AWG branch ² | 4@220V | 4@220V | 4@220V |
| | 5@230V | 4@230V | 4@230V |
| | 5@240V | 4@240V | 4@240V |
| Maximum units per 12 AWG branch ² | 3@220V | 3@220V | 3@220V |
| | 4@230V | 3@230V | 3@230V |
| | 4@240V | 3@240V | 3@240V |
| Current inrush [a.c. A] | 12 | | |
| Max output fault current [a.c. A] | 16 | | |
| Max output overcurrent protection [a.c. A] | 15 | | |
| Total harmonic distortion [%] | <3 | | |

Technical Data

Note:

*1 Nominal AC voltage/frequency range may vary according to local rules and regulations.

*2 Refer to local rules and regulations for the specific number of microinverters per branch.

• Efficiency, Standard and Environment Limit

| Model | X1-Micro 1300 | X1-Micro 1500 | X1-Micro 1600 |
|----------------------------------|---|--|---------------|
| Efficiency | | | |
| Nominal MPPT efficiency | | 99.5% | |
| Maximum efficiency | | 96.5% | |
| Night power consumption [mW] | | <40 | |
| Standard | | | |
| Safety | | IEC62109 | |
| EMC | | IEC 61000, EN 62920, EN 301489, EN 55011 | |
| Grid Connection Standard | IEC 61727, IEC 62116, EN 50549, VDE 4105, UNE217001, UNE217002, RD244/647, NTS Version 2.1 TYPE A, INMETRO, PEA/MEA | | |
| Environment Limit | | | |
| Ingress protection rating | | IP67 | |
| Operating temperature range [°C] | | -40 to 65 | |
| Humidity [%] | | 0 ~ 100(condensing) | |
| Storage temperature [°C] | | -40 to 65 | |
| Model | X1-Micro 1800 | X1-Micro 2000 | X1-Micro 2200 |
| Efficiency | | | |
| Nominal MPPT efficiency | | 99.5% | |
| Maximum efficiency | | 96.5% | |
| Night power consumption [mW] | | <40 | |
| Standard | | | |
| Safety | | IEC62109 | |
| EMC | | IEC 61000, EN 62920, EN 301489, EN 55011 | |
| Grid Connection Standard | IEC 61727, IEC 62116, EN 50549, VDE 4105, UNE217001, UNE217002, RD244/647, NTS Version 2.1 TYPE A, INMETRO, PEA/MEA | | |
| Environment Limit | | | |
| Ingress protection rating | | IP67 | |
| Operating temperature range [°C] | | -40 to 65 | |
| Humidity [%] | | 0 ~ 100(condensing) | |
| Storage temperature [°C] | | -40 to 65 | |

• Generic Data

| Model | X1-Micro 1300 | X1-Micro 1500 | X1-Micro 1600 |
|----------------------------|------------------------|---------------|---------------|
| Dimensions (W/H/D)[mm] | 322 x 242 (302) x 48.5 | | |
| Net weight [kg] | 6.2 | | |
| Heat dissipation treatment | Natural convection | | |
| Monitoring ³ | SolaXCloud | | |
| Communication interface | Built-in Wi-Fi | | |



| Model | X1-Micro 1800 | X1-Micro 2000 | X1-Micro 2200 |
|----------------------------|------------------------|---------------|---------------|
| Dimensions (W/H/D)[mm] | 322 x 242 (302) x 48.5 | | |
| Net weight [kg] | 6.2 | | |
| Heat dissipation treatment | Natural convection | | |
| Monitoring ³ | SolaXCloud | | |
| Communication interface | Built-in Wi-Fi | | |

Note:

* 3 SolaX monitoring platform.

8 Appendix

8.1 INSTALLATION MAP

|  Microinverter Installation Map | | CUSTOMER INFORMATION: | | | | | | | | | | GENERAL INFORMATION: | | | | | |
|---|--------|-------------------------------------|---|---|---|---|---|---|---|---|----|----------------------|----|----|----|----|----|
| | | Example: Address: Street, Ct. | | | | | | | | | | | | | | | |
| Make sure N for North  | | 1 | 2 | 3 | 4 | 5 | 6 | 7 | 8 | 9 | 10 | 11 | 12 | 13 | 14 | 15 | 16 |
| ROW | COLUMN | | | | | | | | | | | | | | | | |
| A | | | | | | | | | | | | | | | | | |
| B | | | | | | | | | | | | | | | | | |
| C | | | | | | | | | | | | | | | | | |
| D | | | | | | | | | | | | | | | | | |

8.2 WIRING DIAGRAM – 230VAC SINGLE PHASE

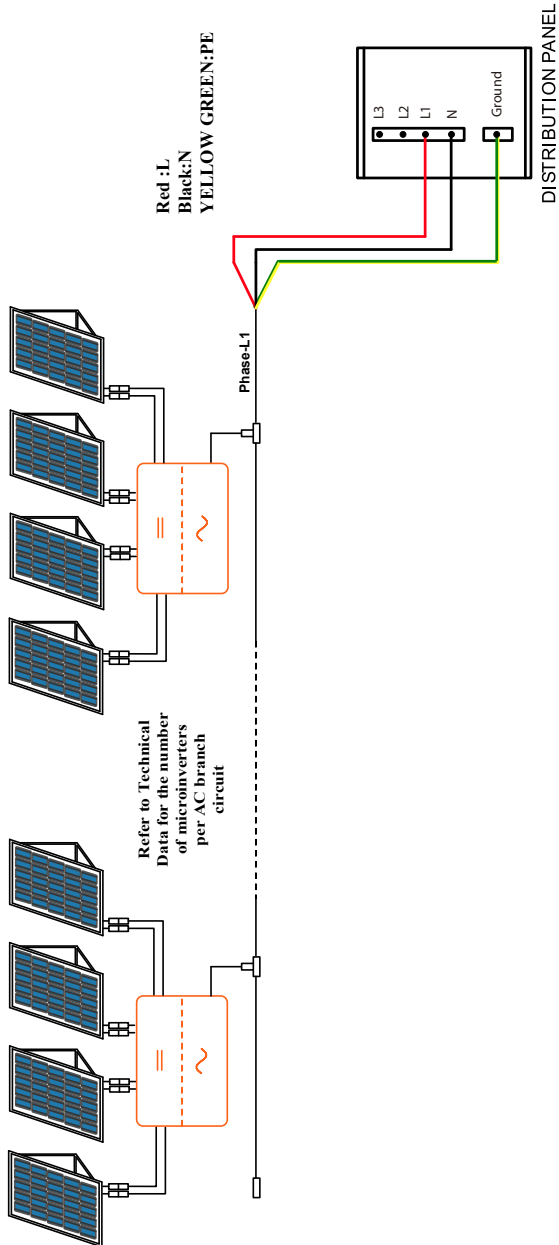

8.3 WIRING DIAGRAM –120VAC 240VAC SPLIT PHASE

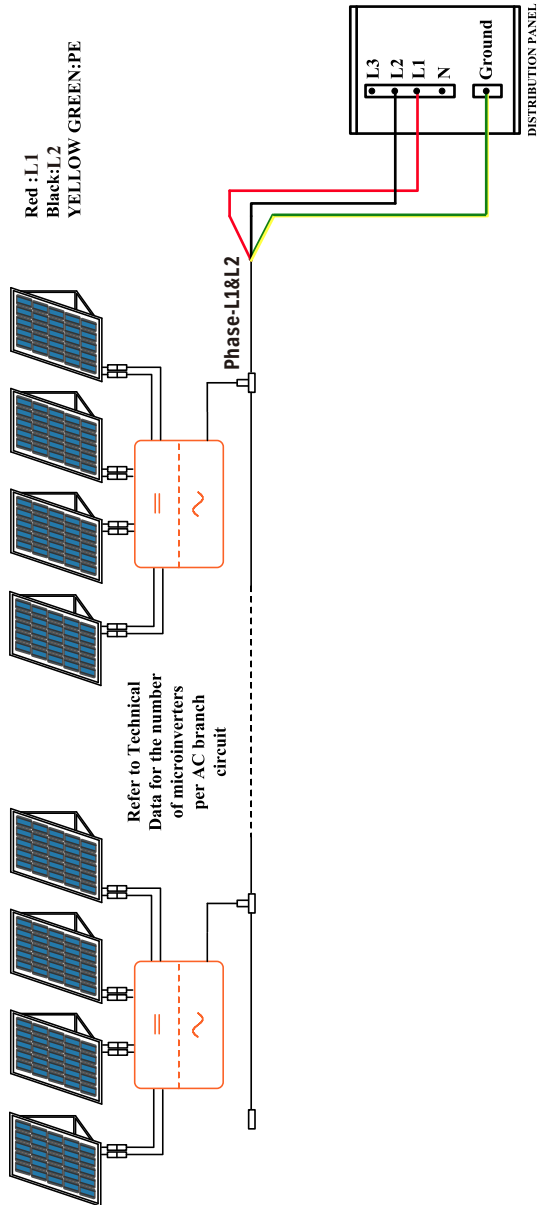

8.4 WIRING DIAGRAM – 230VAC THREE PHASE

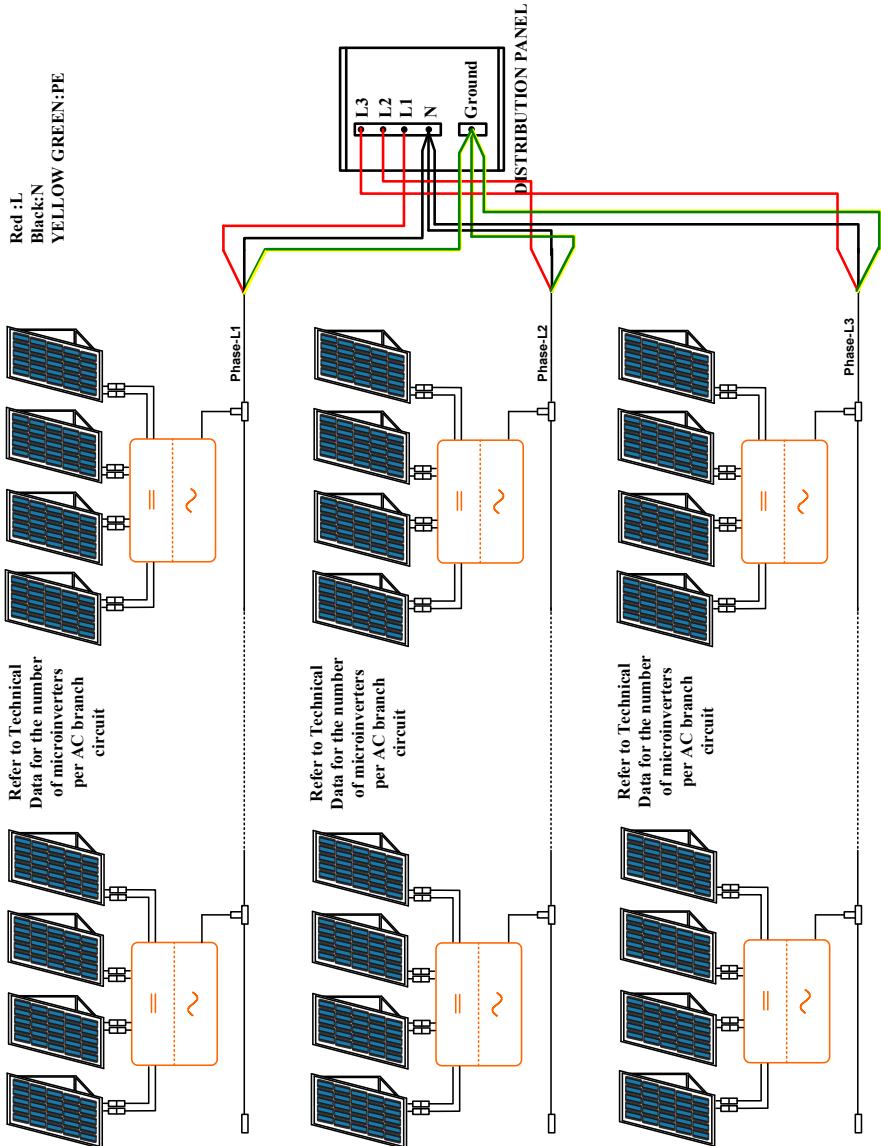

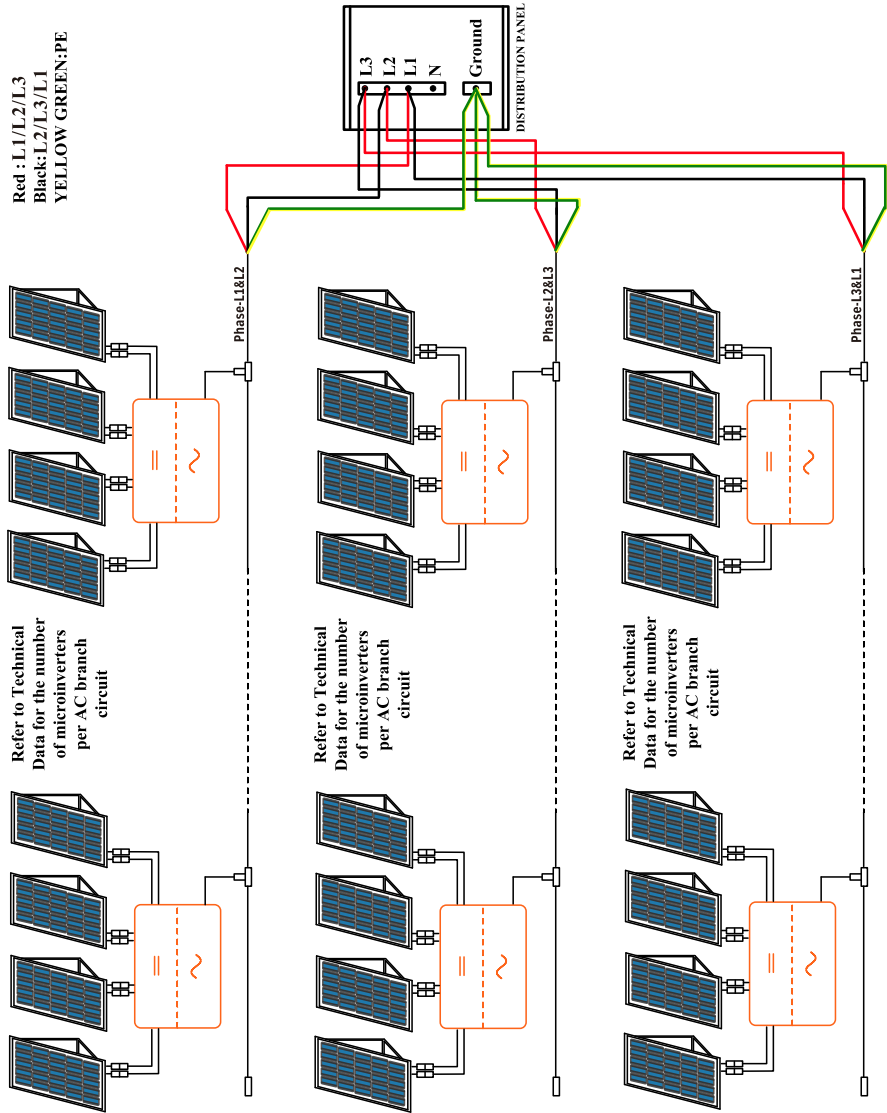

8.5 WIRING DIAGRAM 120VAC 208VAC Three-Phase



Contact Information





UNITED KINGDOM

 Unit C-D Riversdale House, Riversdale Road, Atherstone, CV9 1FA
 +44 (0) 2476 586 998
 service.uk@solaxpower.com





AUSTRALIA

 21 Nicholas Dr, Dandenong South VIC 3175
 +61 1300 476 529
 service@solaxpower.com





TURKEY

 Fevzi Çakmak mah. aslım cd. no 88 A Karatay / Konya / Türkiye
 service.tr@solaxpower.com





GERMANY

 Am Tullnaupark 8, 90402 Nürnberg, Germany
 +49 (0) 6142 4091 664
 service.eu@solaxpower.com
 service.dach@solaxpower.com







USA

 3780 Kilroy Airport Way, Suite 200, Long Beach, CA, US 90806
 +1 (408) 690 9464
 info@solaxpower.com





NETHERLANDS

 Twekkeler-Es 15 7547 ST Enschede
 +31 (0) 8527 37932
 service.eu@solaxpower.com
 service.bnl@solaxpower.com





POLAND

 WARSAW AL. JANA P. II 27. POST
 +48 662 430 292
 service.pl@solaxpower.com





SPAIN

 +34 9373 79607
 tecnico@solaxpower.com





ITALY

 +39 011 19800998
 support@solaxpower.it



BRAZIL

 +55 (34) 9667 0319
 info@solaxpower.com



PAKISTAN

 service.pk@solaxpower.com



SOUTH AFRICA

 service.za@solaxpower.com

Warranty Registration Form



For Customer (Compulsory)

Name _____ Country _____
Phone Number _____ Email _____
Address _____
State _____ Zip Code _____
Product Serial Number _____
Date of Commissioning _____
Installation Company Name _____
Installer Name _____ Electrician License No. _____

For Installer

Module (If Any)

Module Brand _____
Module Size(W) _____
Number of String _____ Number of Panel Per String _____

Battery (If Any)

Battery Type _____
Brand _____
Number of Battery Attached _____
Date of Delivery _____ Signature _____

Please visit our warranty website: <https://www.solaxcloud.com/#/warranty> or use your mobile phone to scan the QR code to complete the online warranty registration.



For more detailed warranty terms, please visit SolaX official website: www.solaxpower.com to check it.





CE Statement

SolaX Power Network Technology (Zhejiang) Co., Ltd. declares that this X1-Micro 4 in 1 is in compliance with the essential requirements and other relevant provisions of Directive 2014/53/EU. In accordance with Article 10(2) and Article 10(10), this product allowed to be used in all EU member states.

Safe distance warning

Use the X1-Micro 4 in 1 in the environment with the temperature between -40°C and 65°C, The device complies with RF specifications when the device used at 20cm from your body. Risk of explosion if battery is replaced by an incorrect type.

Operation Frequency:

WIFI: 2.4G

Frequency: 2412MHZ-2484MHz

Output Power: 802.11 b/g/n20/n40: <19.5dBm(e.i.r,p)



Importer:

Authorised Representative (UK)

Name: SOLAX POWER UK LIMITED

Add: Unit C-D Riversdale House, Riversdale Road, Atherstone, CV9 1FA

Tel: +44 (0) 2476 586 998

E-mail: service.uk@solaxpower.com

Authorised Representative (AUS)

Name: SolaX Power AUS Pty Ltd

Add: 21 Nicholas Dr, Dandenong South VIC 3175

Tel: +61 1300 476 529

E-mail: service@solaxpower.com

Authorised Representative (EU)

Name: SolaX Power NL Company BV

Add: Twekkeler Es 15,7547 ST, Enschede, Netherlands

Tel: +31 (0)85 2737 932

E-mail: service.eu@solaxpower.com



SolaX Power Network Technology (Zhejiang) Co., Ltd.

ADD.: No. 278, Shizhu Road, Chengnan Sub-district, Tonglu County,
Hangzhou, Zhejiang, China

E-mail: info@solaxpower.com

www.solaxpower.com

Copyright © SolaX Power Network Technology (Zhejiang) Co., Ltd. All rights reserved.



320101100101